

Heating

Cooling

Fresh Air

Clean Air





### **Read this document carefully before use.**

With this document you can operate and perform the maintenance of the ComfoAir Q in a safe and optimal manner. In this document the ComfoAir Q will be referred to as “the unit”. The unit is subject to continuous development and improvement. Thus the unit may be slightly different from the given descriptions.

The pictograms that follow are used in this document:

Symbol	Meaning
	Point of interest.
	Risk of compromised performance or damage of the ventilation system.
	Risk of personal injury.

### **!?** Questions

Please contact the supplier if you have any questions or would like to order a new document or new filters. The contact details of the main supplier can be found on the back page of this document.

### **Use of the unit**

The unit may only be used when it is properly installed according to the instructions and guidelines in the installer manual of the unit.

The unit can be used by:

- children aged from 8 years and above;
- persons with reduced physical capabilities;
- persons with reduced sensory capabilities;
- persons with reduced mental capabilities;
- persons with lack of experience and knowledge, if they have been given supervision or instruction concerning use of the unit in a safe way and understand the hazards involved.

Children shall not play with the unit.

Cleaning and user maintenance shall not be carried out by children without supervision.

### **All rights reserved.**

This documentation has been made with the utmost care. The publisher cannot be held liable for any damage caused as a result of missing or incorrect information in this document. In case of disputes the English version of the instructions will be binding.

# Table of Contents

Foreword.....	2
1 Introduction and safety.....	5
2 Description.....	6
2.1 Available operating devices.....	6
2.2 Optional ancillaries.....	7
2.3 Overview of the unit.....	8
2.4 Overview of the unit display.....	8
2.5 Menu structure.....	10
3 Operation.....	11
3.1 Access the unit display.....	11
3.2 Activate/deactivate the child lock.....	11
3.3 How to navigate through the unit menu.....	11
3.4 Changing the airflow.....	12
3.4.1 Bathroom switch (BOOST function from the bathroom).....	12
3.4.2 Manually on the unit display.....	12
3.4.3 Maximum (BOOST) for a specific duration.....	13
3.4.4 Stop the airflow for a specific duration.....	13
3.4.5 Minimum (AWAY) for a specific duration of your absence.....	14
3.5 Setting the comfort options.....	15
3.5.1 Temperature profile.....	15
3.5.2 Postheater control for a specific duration.....	16
3.5.3 Scheduler.....	16
3.5.4 Bypass heat recovery for a specific duration.....	18
3.5.5 Stop ComfoCool Q for a specific duration.....	18
3.6 Checking the status of the unit.....	19
3.7 Setting the unit clock.....	20
3.8 Setting the unit display brightness.....	21
3.9 Reset options.....	21
3.10 Advanced mode.....	22
3.10.1 Switch between basic and advanced mode.....	22
3.10.2 SENSOR VENTILATION <sup>2</sup> .....	22
3.10.3 TEMPERATURE PROFILE <sup>2</sup> .....	23
3.10.4 UNITS <sup>2</sup> .....	23
3.10.5 SEASON DETECTION <sup>2</sup> .....	23
3.10.6 RF SETTINGS <sup>2,8</sup> .....	23
3.10.7 POSTHEATER <sup>2,3</sup> .....	23

<sup>2</sup> This menu is only visible when the advanced mode is active.

<sup>3</sup> This menu is only visible when the ancillary is connected to the unit.

<sup>8</sup> This menu is only visible when the unit has RF functionality.

4	Certification and warranty .....	24
5	Maintenance .....	25
	5.1 Fill the condensation drain.....	25
	5.2 Clean the operating device.....	25
	5.3 Clean the grilles.....	25
	5.4 Clean the valves.....	26
	5.5 Replacing the internal filters.....	27
	5.5.1 View filter status .....	27
	5.5.2 Postponing filter warning.....	27
	5.5.3 Replacement instruction .....	28
	5.6 Replace or clean the external filter .....	28
6	Malfunctions.....	29
	6.1 Airflow is not as expected. ....	30
	6.2 Condensation on the outside of the unit and/or air ducts.....	30
	6.3 Software update.....	30
	6.4 ComfoCool Q600 is not turning on .....	30
	6.5 Postheater is not turning on.....	30
	6.6 Supply air is too cold .....	30
I	Commissioning & Inspection Record.....	31
II	Maintenance log .....	34

## 1 Introduction and safety

The unit is a balanced ventilation system with heat recovery in order to create energy-efficient ventilation in houses. Balanced ventilation means that pollutants from the kitchen, bathroom, wc(s) and possibly the utility room are extracted, while the same amount of fresh air is supplied into the living room and bedrooms. Gaps under or near doors ensure a good through-flow in the dwelling.

**⚠ Ensure that the gaps under or near doors are never obstructed. For example by furniture, draught excluders or deep-pile carpet.**

A balanced ventilation system consists of:

- The unit (A);
- Duct system for the intake of outdoor air (B);
- Duct system for the extract of indoor air (C);
- Supply valves and/or grilles in the living room and bedrooms (D);
- Extract valves and/or grilles in the kitchen, bathroom, wc and (if present) the utility room (E).

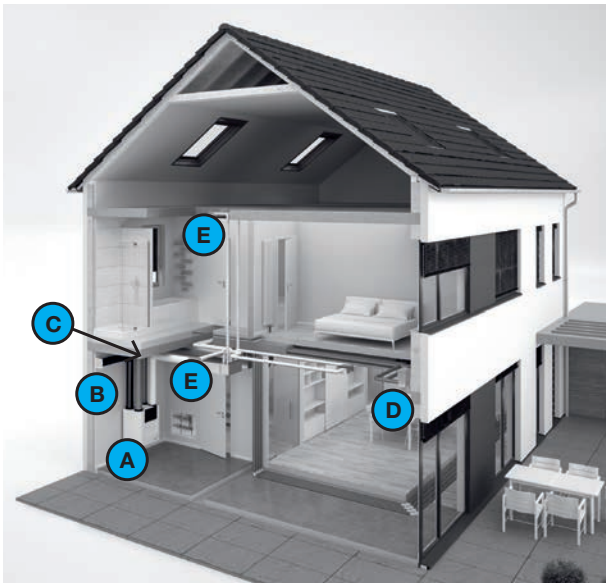

## Safety instructions

- Always obey the safety regulations, warnings, comments and instructions given in this document. When the safety regulations, warnings, comments and instructions in this document are not obeyed personal injury or damage to the unit can occur.
- Do not open the casing. The installer makes sure that all parts that can cause personal injury are behind the casing;
- The installation, commissioning and maintenance must be carried out by a certified engineer unless the instructions state otherwise. A non-certified engineer can cause personal injury or damage the performance of the ventilation system;
- Do not modify the unit or the specifications given in this document. A modification can cause personal injury or damage the performance of the ventilation system;
- Do not disconnect the power to the unit, unless instructed otherwise in the manual. This can lead to a build-up of moisture and result in problems with mould;
- Clean any grille present in and outside your home at least every six months;
- Clean any valve present in your home at least every six months;
- Replace the filters at least every six months. This will insure a comfortable and healthy air quality and will protect the unit from pollution.

## Use during disasters







If a disaster calls for you to close all doors and windows you must also stop the unit. You can do this in one of the following ways:

- Switch off the power supply to the unit at the fuse box or isolation switch;
- Pull out the power supply cable from the outlet to which the unit is connected.

## 2 Description

### 2.1 Available operating devices

One or more operating devices can be connected to operate the unit. Some devices only provide manual control, other devices provide additional automatic control. Such automatic control is based on a time scheduler or on measurements of temperature, relative humidity or other conditions. One or more of the operating devices that follow can be connected to operate the unit:

Appearance Example	Name	Function
	Unit display	For manual and automatic control of the unit. The automatic control is based on the unit settings and adjustable scheduler.
	Zehnder ComfoSense C 67	For remote manual and automatic control of the unit. The automatic control is based on the unit settings and adjustable scheduler. This is a wired control with a wireless receiver.
	Zehnder ComfoSwitch C 67	For basic remote manual and automatic control of the unit. The automatic control is based on the unit settings. This is a wired control.
	Zehnder ComfoControl App	For remote manual and automatic control of the unit with a smartphone or tablet (iOS and Android compatible). The automatic control is based on the unit settings and adjustable scheduler. This is a wireless control. For the ComfoControl App a connected ComfoConnect LAN C is required.
	Zehnder Timer RF	For remote manual control of the unit. This is a wireless control.
	Zehnder CO <sub>2</sub> sensor	For remote automatic control of the unit. The automatic control is based on the amount of CO <sub>2</sub> . This is a wired sensor connected to the Option Box.
	Bathroom switch	To manually switch the unit to the BOOST function from the bathroom. This is a wired switch connected to the Option Box.

## 2.2 Optional ancillaries

The installer can combine several devices with the unit to extend the possibilities.

Appearance Example	Name	Function
	Zehnder ComfoSplitter	Provides 5 additional ComfoNet connectivity options when the ComfoSplitter is connected to 230V.
	Zehnder ComfoConnect KNX C	Provides KNX connectivity options.
	Zehnder ComfoConnect LAN C	Provides LAN connectivity options for remote control with the ComfoControl app.
	Zehnder ComfoCool Q600	Decreases the temperature and pre-conditions the humidity of the supply air.
	Zehnder Option Box	Provides additional connectivity options.
	Zehnder ComfoFond-L Q (or regulated sub-soil heat exchanger)	Pre-conditions the temperature of the outdoor airflow before it enters the unit. This ancillary is connected to the Option Box.
	Zehnder ComfoAir Q pre-heater	Increases the temperature of the outdoor airflow in order to protect the heat exchanger against frost. This ancillary is build-in to the unit and not visible on the outside of the unit.
	Post-heater	Increase the temperature of the supply air. This ancillary is connected to the Option Box.
	External filter	Filters pollen from the outdoor air.
	Malfunction or dirty filter alert	Remotely check the error status of the unit. This ancillary is connected to the Option Box.
	Standby switch	Stops the unit remotely. This ancillary is connected to the Option Box.
	Zehnder RF-PCB	Wireless RF receiver to give wireless connectivity without the use of a ComfoSense C. Wireless RF receiver to give wireless connectivity. This ancillary is build-in to the unit and not visible on the outside of the unit.

## 2.3 Overview of the unit

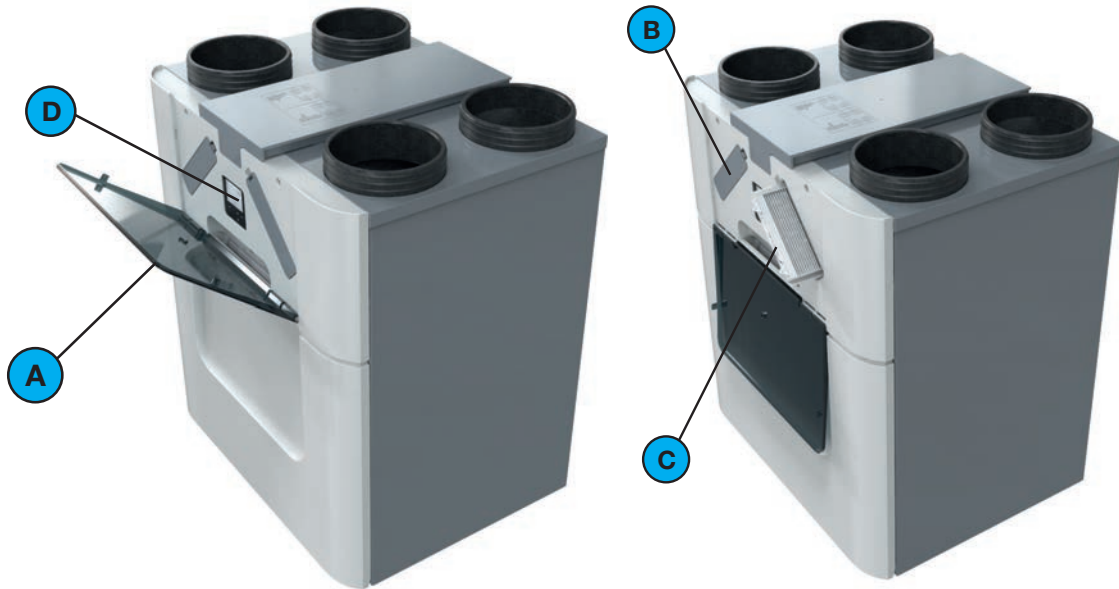

Position	Part
A	Semi-transparent visor for access to the display and the filter caps.
B	2 filter caps for easy access to the filters.
C	2 filters for air filtering.
D	Display to operate the unit.

## 2.4 Overview of the unit display

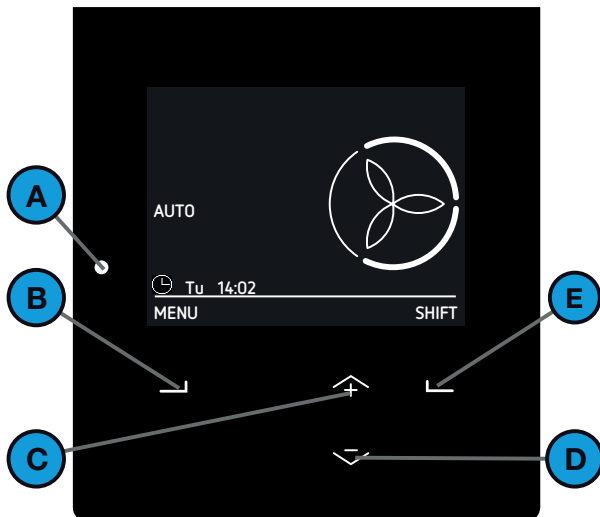

Position	Part
A	Status indicator LED light. <ul style="list-style-type: none"> <li>■ On = The unit is operating correctly;</li> <li>■ Off = The unit has no power or the display is in use;</li> <li>■ Slowly flashing (every second) = Warning (Change filters or SERVICE MODE active);</li> <li>■ Rapidly flashing (four times a second) = Error.</li> </ul>
B	Universal button. The function depends on the current text on the display above the button.
C	Up button to: <ul style="list-style-type: none"> <li>■ Increase preset;</li> <li>■ Increase value;</li> <li>■ Select the previous item.</li> </ul>
D	Down button to: <ul style="list-style-type: none"> <li>■ Decrease preset;</li> <li>■ Decrease value;</li> <li>■ Select the next item.</li> </ul>
E	Universal button. The function depends on the current text on the display above the button.



There are two user modes available on the unit:

- The basic mode provides access to general settings and information on the main screen and in the menu screen.

The symbol  is displayed in the left top corner of the menus when the basic mode is active.





- The advanced mode provides access to more detailed information on the main screen and in the menu screen.



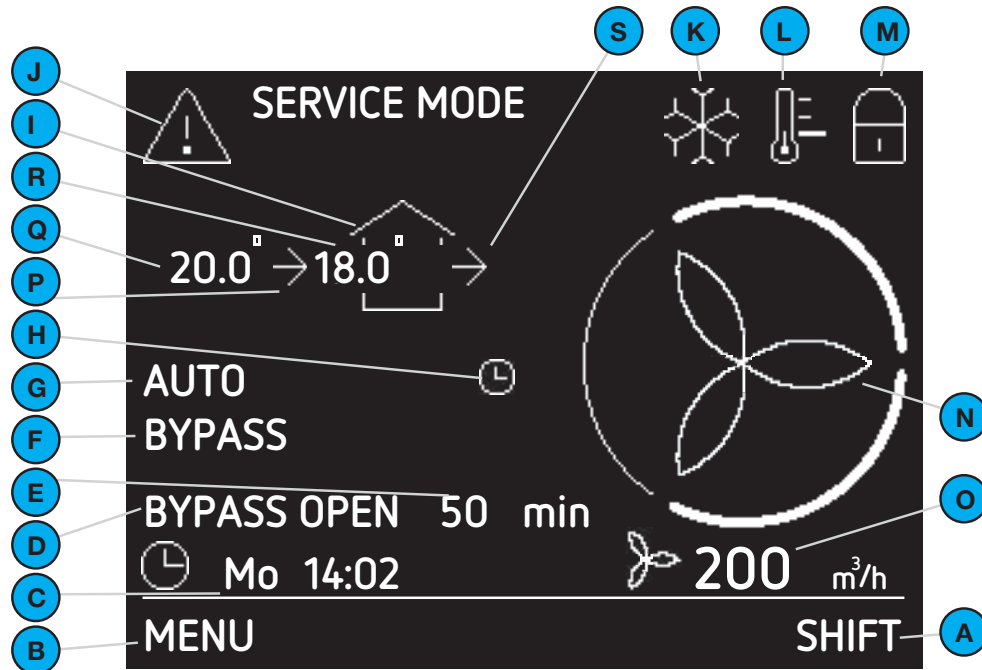





All information from the basic mode is also accessible in the advanced mode.

The symbol  is displayed in the left top corner of the menus when the advanced mode is active.

### Overview Main screen



Position	Part
A	Current function of the universal button below it.
B	Current function of the universal button below it.
C	Current day and time.
D	Current operating function.
E	Remaining time of current operating function.
F	Current active automated control.
G	Current ventilation mode: <ul style="list-style-type: none"> <li>■ AUTO = the airflow is set by the scheduler;</li> <li>■ MANUAL = the airflow is set by the user.</li> </ul>
H	Temporary override of the SCHEDULER VENTILATION.
I	Current fan mode: <ul style="list-style-type: none"> <li>■ no icon = both fans are in operation (BALANCE);</li> <li>■  = extract fan is not in operation (SUPPLY ONLY);</li> <li>■  = supply fan is not in operation (EXTRACT ONLY);</li> <li>■  = both fans are not in operation</li> </ul>
J	Current warning or error message: <ul style="list-style-type: none"> <li>■  = Warning;</li> <li>■  = Error.</li> </ul>
K	ComfoCool Q600 is in operation.

Position	Part
L	Current set temperature profile: <ul style="list-style-type: none"> <li>■ no icon = NORMAL.</li> <li>■  = WARM;</li> <li>■  = COOL.</li> </ul>
M	Child lock is in operation.
N	Current set airflow: <ul style="list-style-type: none"> <li>■  = PRESET A (Away)</li> <li>■  = PRESET 1 (Low)</li> <li>■  = PRESET 2 (Middle)</li> <li>■  = PRESET 3 (High)</li> </ul> <p>When an automated control requires more airflow than requested the extra airflow segment is blinking.</p>
<b>Only available in advanced mode</b>	
O	Current airflow volume in m³/h or l/s.
P	Current supply fan mode: <ul style="list-style-type: none"> <li>■ no icon = fan is not in operation;</li> <li>■  = fan is in operation.</li> </ul>
Q	Current outdoor air temperature in °C or °F. (Only visible when the supply fan is active)
R	Current supply air temperature °C or °F. (Only visible when the supply fan is active)
S	Current extract fan mode: <ul style="list-style-type: none"> <li>■ no icon = fan is not in operation;</li> <li>■  = fan is in operation.</li> </ul>

## 2.5 Menu structure

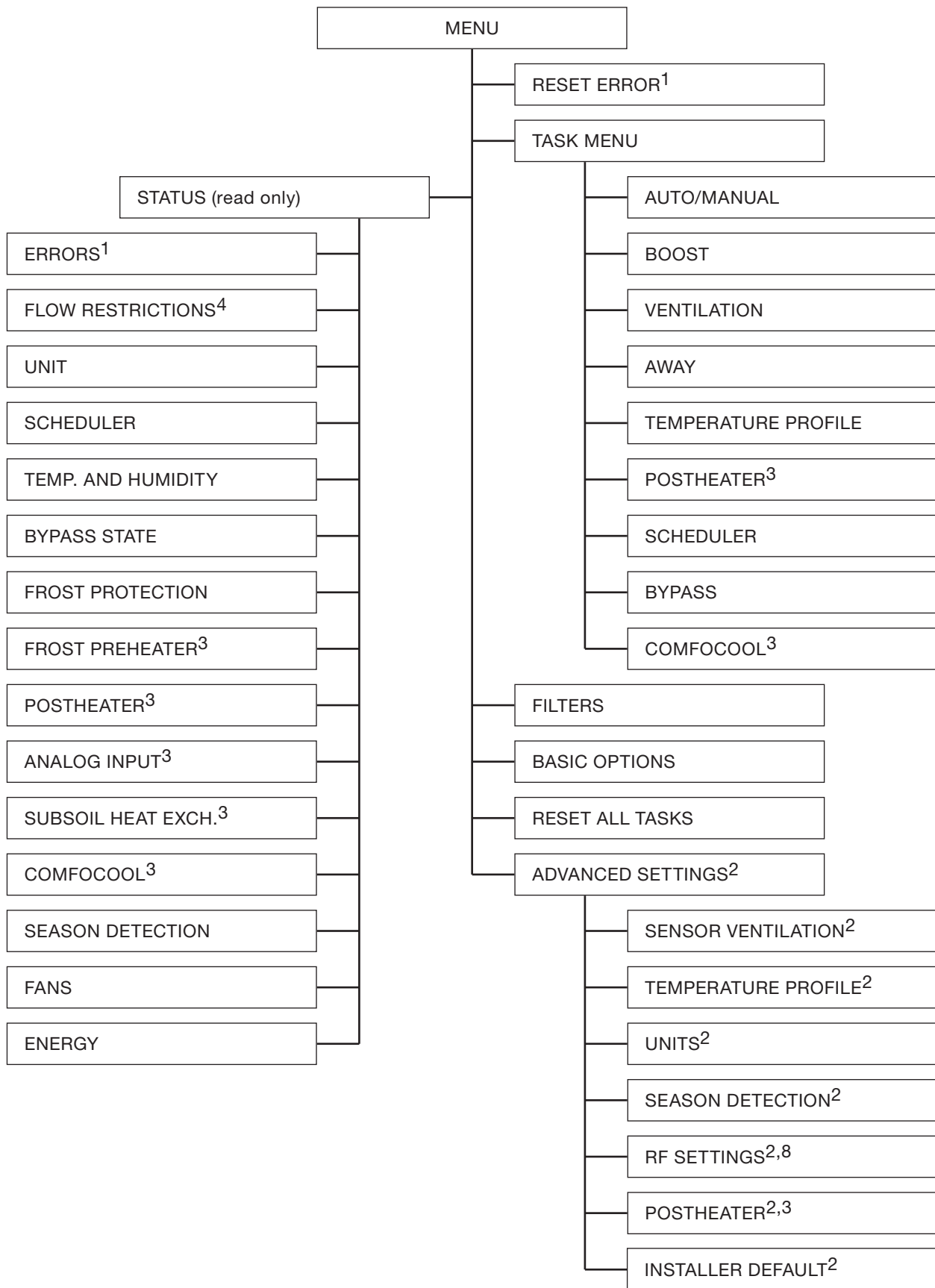

<sup>1</sup> This menu is only visible when errors occur.

<sup>2</sup> This menu is only visible when the advanced mode is active.

<sup>3</sup> This menu is only visible when the ancillary is connected to the unit.

<sup>4</sup> This menu is only visible when an automated control requires a different airflow setting than requested.

<sup>8</sup> This menu is only visible when the unit has RF functionality.

### 3 Operation

A number of important conditions must be met to ensure the unit functions properly:

- Ensure that no condenser dryer is placed in the same room as the unit. A condenser dryer may cause a higher humidity than the unit was built for;
- Ensure that the gaps under or near doors are never obstructed. For example by furniture, draught excluders or deep-pile carpet.

The unit is operated with its own display, a switch or sensor. One or more switches and/or sensors can be fitted in the house (e.g. in the kitchen).

**If the dwelling has more switches and/or sensors, then the unit will set the highest requested ventilation setting.**

Depending on the type of switch used, the unit is automatically or manually operated. More on the use of the switches and sensors fitted can be found in the manuals of those switches and sensors. More about the use of the unit display can be found in this document.

#### 3.1 Access the unit display

To save energy the unit display screen will be off most of the time. The display will automatically turn off after 15 minutes of no activity. The following actions will make the screen visible:

- Open the semi-transparent visor;
- Press any key on the display.

#### 3.2 Activate/deactivate the child lock

To prevent unwanted changes to the settings, the unit display is equipped with a child lock. As long as the child lock is enabled the symbol  is visible on the main screen.

Select and hold MENU in the main screen for 4 seconds to activate or deactivate the child lock.

#### 3.3 How to navigate through the unit menu

1. Open the semi-transparent visor.
2. Select MENU to gain access to the menus.
3. Use the up and down button to navigate forward and back through the menus.
4. When the selection arrow is in front of the desired option select CONFIRM.

When you are done with all your operating options:

1. Select BACK until you reach the main screen.
2. Close the semi-transparent visor.

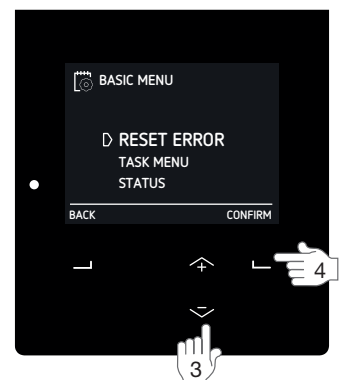
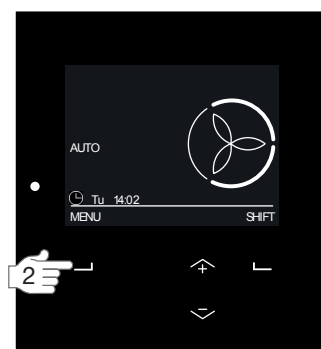
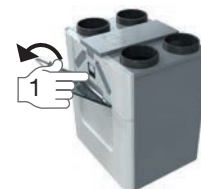
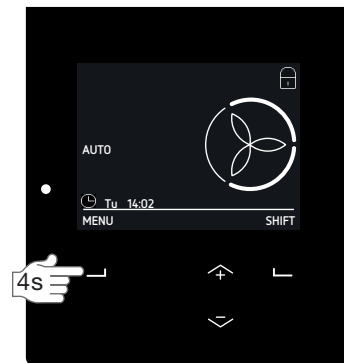

### 3.4 Changing the airflow

Clean air at home is important to your health. Did you know, for instance, that you need 25m<sup>3</sup> (25,000 liters) clean fresh air per hour? In addition, air containing pollutants such as CO<sub>2</sub> must also be removed from your home. Good ventilation is therefore pure necessity. Balance ventilation provides this for you in a comfortable way.

The unit can be set to provide the necessary clean air automatically, but can also be overruled when you think you need more or less airflow.

#### 3.4.2 Manually on the unit display



To set a temporary airflow press the up or down button to select the desired temporary airflow.

When the next step of the SCHEDULER VENTILATION starts or after a maximum of two hours the unit will automatically switch back to AUTO mode.

To set a permanent airflow change:

1. Navigate to TASK MENU as instructed in the chapter "How to navigate through the unit menu".
2. Navigate to AUTO/MANUAL.
3. Navigate to MANUAL.
4. Select the desired airflow with the up and down button.
  - A (away) if the house will be empty;
  - 1 (low) if you want low ventilation;
  - 2 (middle) if you require normal ventilation;
  - 3 (high) if you have a party, are cooking or want to shower.
5. Select CONFIRM.
6. Select CONFIRM.

Stop the MANUAL mode:

1. Repeat step 1 and 2.
2. Navigate to AUTO.

 In some cases the setting of the airflow may be changed by an internal software control e.g. the settings of the SENSOR VENTILATION<sup>2</sup>. In the menu FLOW RESTRICTIONS you can see if and which software control is restricting the airflow automatically.

#### 3.4.1 Bathroom switch (BOOST function from the bathroom)



The unit is equipped with an optional time control to quickly decrease the moisture in your bathroom. This is done by setting the airflow to PRESET 3 with a switch in the bathroom. There

are two timers for this bathroom switch:

- Overrun timer<sup>9</sup> = time the unit will stay running at PRESET 3 after turning off the bathroom switch;
- Delay timer<sup>9</sup> = time before the unit will start running at PRESET 3 after turning on the bathroom switch.

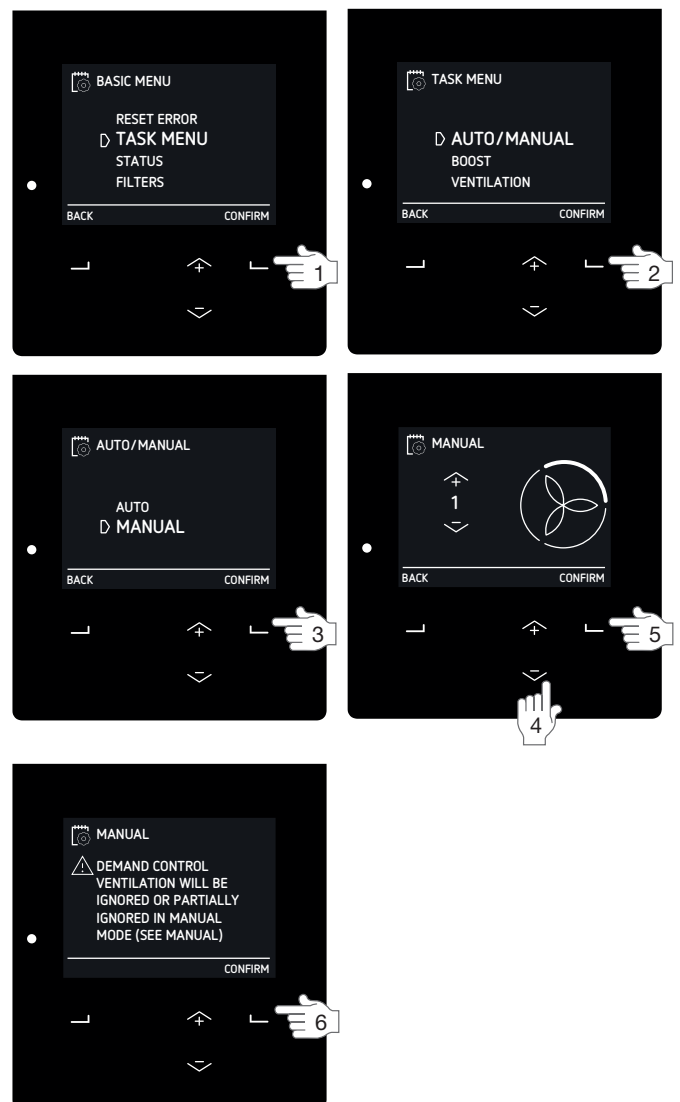

<sup>2</sup> This menu is only visible when the advanced mode is active.

<sup>9</sup> This value is set by the installer.

### 3.4.3 Maximum (BOOST) for a specific duration



It is possible to set a timer on the airflow setting PRESET 3. This way you do not need to change the airflow setting back after a party, cooking or showering. You just set the expected time you need airflow setting PRESET 3.

1. Navigate to TASK MENU as instructed in the chapter “How to navigate through the unit menu”.
2. Navigate to BOOST.
3. Navigate to TIMER.
4. Select the desired duration with the up and down button.
5. Select CONFIRM.

To stop the boost before the timer ends:

1. Repeat step 1 and 2.
2. Navigate to OFF.



### 3.4.4 Stop the airflow for a specific duration



When desired, the supply or extract fan of the unit can temporary be turned off. Turning the supply fan off may be desired to keep out unpleasant odours from outside.

1. Navigate to TASK MENU as instructed in the chapter “How to navigate through the unit menu”.
2. Navigate to VENTILATION.
3. Navigate to:
  - SUPPLY ONLY if you would like to stop extracting air;
  - EXTRACT ONLY if you would like to stop supplying air (if available);
4. Select the desired duration with the up and down button.
5. Select CONFIRM.
6. Select CONFIRM.

To restart the fan before the timer ends:

1. Repeat step 1 and 2.
2. Navigate to BALANCE.

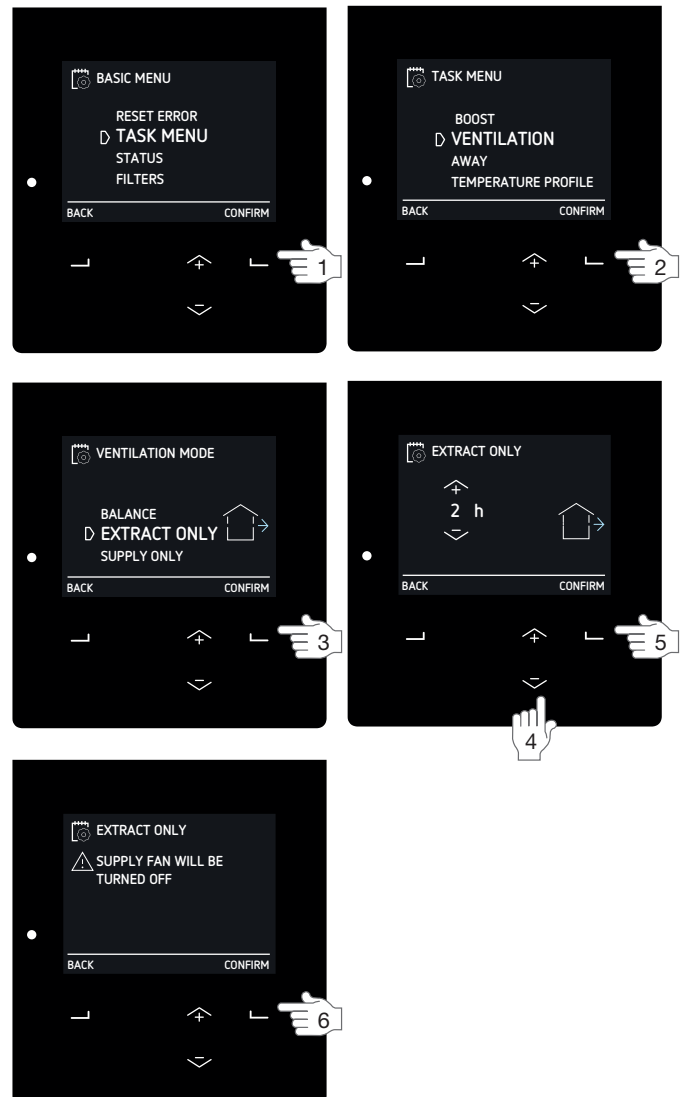

**⚠ Do not use this function to turn off the ventilation during disasters. Follow the instructions in the chapter “Introduction and safety” instead.**

### 3.4.5 Minimum (AWAY) for a specific duration of your absence



It is possible to set a timer on the airflow setting PRESET A. This way you do not need to change the airflow setting back after coming home. You just set the expected time you need airflow setting PRESET A. During this set time all schedulers will be ignored.

It is best to set the end-time a bit sooner than you expect to come home. This way you will come home to a comfortable and fresh house (e.g. after a long holiday).

1. Navigate to TASK MENU as instructed in the chapter “How to navigate through the unit menu”.
2. Navigate to AWAY.
3. Navigate to UNTIL.
4. Set your expected return time with the up and down button.
5. Select CONFIRM after each set number.

To stop the away mode before the timer ends:

1. Repeat step 1 and 2.
2. Navigate to OFF.

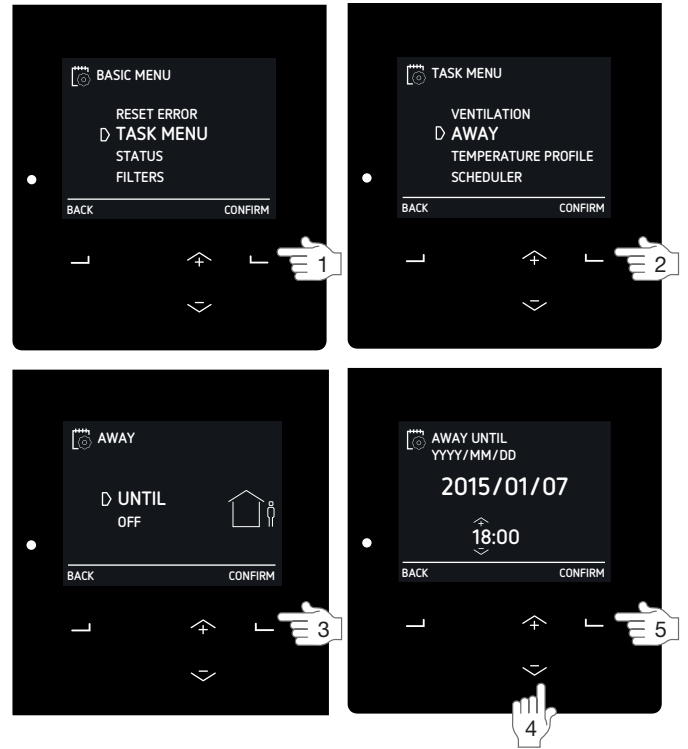

### 3.5 Setting the comfort options

Breathing, cooking, showering and using the toilet: all indoor activities that cause moisture production and polluted air. Continuous ventilation is necessary to refresh the air - and keep the air healthy and comfortable. Failure to do this can result in problems with fungi, bacteria, dust mites, moisture spots and unwanted odors. But the problems don't stop here. What about health problems like allergies, respiratory distress and headache? These are all issues which influence your health, concentration, functioning and performance.

In addition to minimizing CO<sub>2</sub> and moisture problems the unit can also minimise heat problems with its bypass control and with optionally connected ancillaries.

The unit can be set to AUTO mode to achieve the most optimal indoor climate for you as possible, via ventilation and the present optionally connected ancillaries. The factory defaults of the unit are set to provide a comfort level desired by the average person.

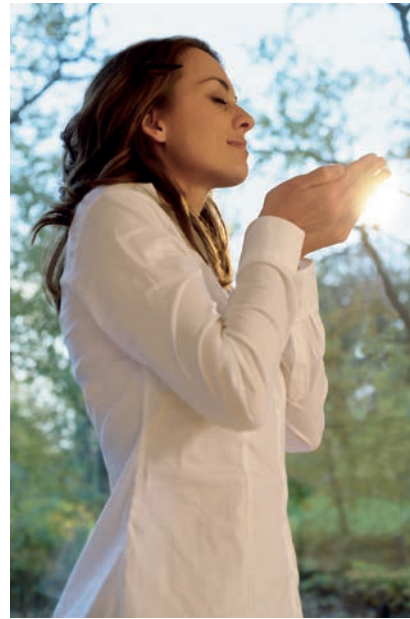

#### 3.5.1 Temperature profile



The amount of heat recovery is controlled automatically based on the set temperature profile. The effect of the set temperature profile on the indoor climate is mainly noticeable in the shoulder seasons (autumn and spring) and limited by external conditions. It will be more pronounced and less season-dependent in case the installation is equipped with one or more of the options that follow:

- active cooling (e.g. ComfoCool Q);
- heating devices (e.g. post-heater);
- a regulated subsoil heat exchanger (e.g. ComfoFond-L Q).

1. Navigate to TASK MENU as instructed in the chapter "How to navigate through the unit menu".
2. Navigate to TEMPERATURE PROFILE.
3. Navigate to the desired temperature profile.
  - WARM: set if you prefer a higher room temperature;
  - NORMAL: set if you prefer average room temperature; (default)
  - COOL: set if you prefer a lower room temperature.



### 3.5.2 Postheater control for a specific duration

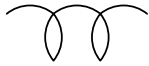

When the unit is equipped with a Postheater you can use it during the heating and shoulder season to heat the supply air.

1. Navigate to TASK MENU as instructed in the chapter "How to navigate through the unit menu".
2. Navigate to POSTHEATER<sup>3</sup>.
3. Navigate to
  - OFF if you would like to turn the postheater off for a specific duration;
  - HEATING if you would like to use the postheater to heat your house to the set temperature profile value;
  - COMF. SUPPLY if you would like to use the postheater to heat the supply air to the set temperature in the ADVANCED SETTINGS menu.
4. Select the desired duration with the up and down button.
5. Select CONFIRM.

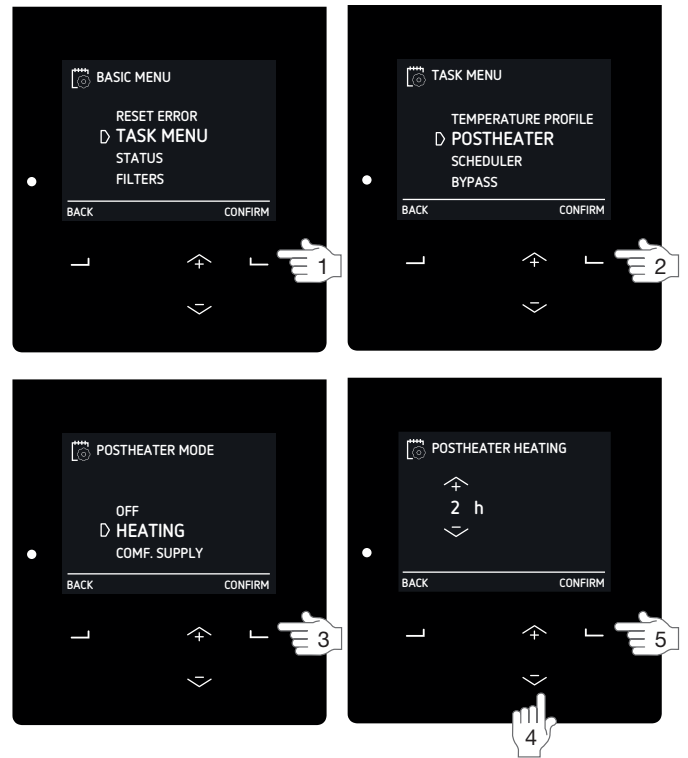

### 3.5.3 Scheduler



Each activity has its own airflow and temperature setting. You can change the airflow and temperature setting manually when your activity changes however it is also possible to program your own activity schedule in the unit.

This can be done for:

- the airflow settings;
- turning off the optionally connected ComfoCool Q;
- changing the control mode of the optionally connected Postheater.

#### Programming rules:

- If programs overlap, the shortest program is the leading program and overrules any longer program;
- If both overlapping programs have an equally long period, the program with the highest airflow PRESET will be the leading program.



**When no schedule is programmed and the AUTO mode is activated the unit will switch to**

- **PRESET 2,**
- **ComfoCool Q AUTO,**
- **Postheater OFF.**

**When MANUAL mode is activated all set schedules will be ignored.**

Example:

Step	Activity	Period	Time	Setting
1	Showering	MO-FR	7:00 – 8:00	
2	Not at home	MO-FR	9:00 – 17:00	
3	Making Lunch	MO-FR	12:30 – 13:00	
4	Breakfast	WEEK	6:00 – 10:00	
5	Lunch	MO-FR	12:00 – 14:00	

Step 1 is shorter than step 4 and will overrule step 4.  
Step 3 is shorter than step 2 and will overrule step 2.



1. Navigate to TASK MENU as instructed in the chapter “How to navigate through the unit menu”.
2. Navigate to SCHEDULER.
3. Navigate to
  - VENTILATION if you would like to set a schedule for the airflow;
  - COMFOCOOL<sup>3</sup> if you would like to set a schedule for the ComfoCool Q;
  - POSTHEATER<sup>3</sup> if you would like to set a schedule for the Postheater.
4. Navigate to
  - VIEW/EDIT to view/change a scheduler step;
  - DELETE to remove a scheduler step.
5. Navigate to
  - NEW to create a new schedule step;
  - STEP to view, change or remove the selected schedule step;
  - ALL to delete all the schedule steps.
6. Navigate to the desired period.
  - WEEK = Every day of the week;
  - MO-FR = Mondays to Fridays;
  - SA-SU = Saturdays and Sundays;
  - MON = Monday;
  - TUE = Tuesday;
  - WED = Wednesday;
  - THU = Thursday;
  - FRI = Friday;
  - SAT = Saturday;
  - SUN = Sunday.
7. Select your desired start time with the up and down button.
8. Select CONFIRM after each number.
9. Select your desired end time with the up and down button.
  - Setting an end time before the start time means the program will end the next day.
10. Select CONFIRM after each number.
11. Navigate to your desired preset for the defined timeslot.
  - AWAY = airflow if the house will be empty;
  - 1 = airflow if you want low ventilation;
  - 2 = airflow if you require normal ventilation;
  - 3 = airflow if you have a party, are cooking or want to shower;
  - AUTO = if the ComfoCool Q must switch on/off automatically;
  - OFF = if the ComfoCool Q / Postheater must switch off;
  - HEATING = if you would like to use the postheater to heat your house to the set temperature profile value;
  - COMF SUPPLY = if you would like to use the postheater to heat the supply air to the set temperature in the ADVANCED SETTINGS menu.
12. To program the next scheduler step go back to step 4.  
To stop programming select BACK until you reach the main screen.



<sup>3</sup> This menu is only visible when the ancillary is connected to the unit.

### 3.5.4 Bypass heat recovery for a specific duration

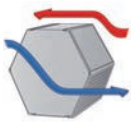

To conserve the indoor temperature the unit is equipped with a heat exchanger which transfers part of the temperature from the extracted air to the supplied air.

(When the unit is equipped with an enthalpy exchanger it also transfers moisture) In some cases this temperature transfer is not desired. Therefore the unit is also equipped with an automated bypass control which can transport the outside air partly or completely into the dwelling without transferring the temperature from the extracted air. When the automated heat recovery control (bypass) is active the maximum air flow (rate) is restricted to avoid extra noise due to higher resistance in the system. When desired, this automated bypass control can be deactivated temporarily.

1. Navigate to TASK MENU as instructed in the chapter “How to navigate through the unit menu”.
2. Navigate to BYPASS.
3. Navigate to
  - ACTIVATED if you would like to minimise the heat recovery (if possible outdoor air is supplied directly into the dwelling);
  - DEACTIVATED if you would like to maximise the heat recovery (as much of the heat from the extracted air will be transferred back to the supply air as possible).
4. Select the desired duration with the up and down button.
5. Select CONFIRM.

To reactivate the automatic bypass control before the timer ends:

1. Repeat step 1 and 2.
2. Navigate to AUTO.
3. Select CONFIRM.
4. Select BACK.
5. Select BACK.

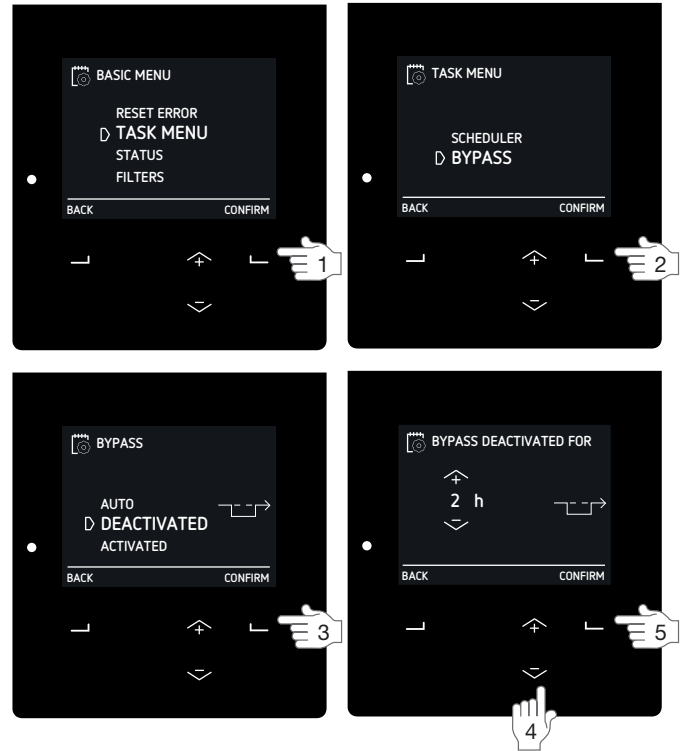

### 3.5.5 Stop ComfoCool Q for a specific duration



When the unit is equipped with a ComfoCool Q600 the unit will use it during the cooling season to temper the supply air.

When desired, the connected ComfoCool Q600 can temporary be turned off.

1. Navigate to TASK MENU as instructed in the chapter “How to navigate through the unit menu”.
2. Navigate to COMFOCOOL<sup>3</sup>.
3. Navigate to OFF.
4. Select the desired duration with the up and down button.
5. Select CONFIRM.

To reactivate the automatic control of the ComfoCool Q before the timer ends:

1. Repeat step 1 and 2.
2. Navigate to AUTO.

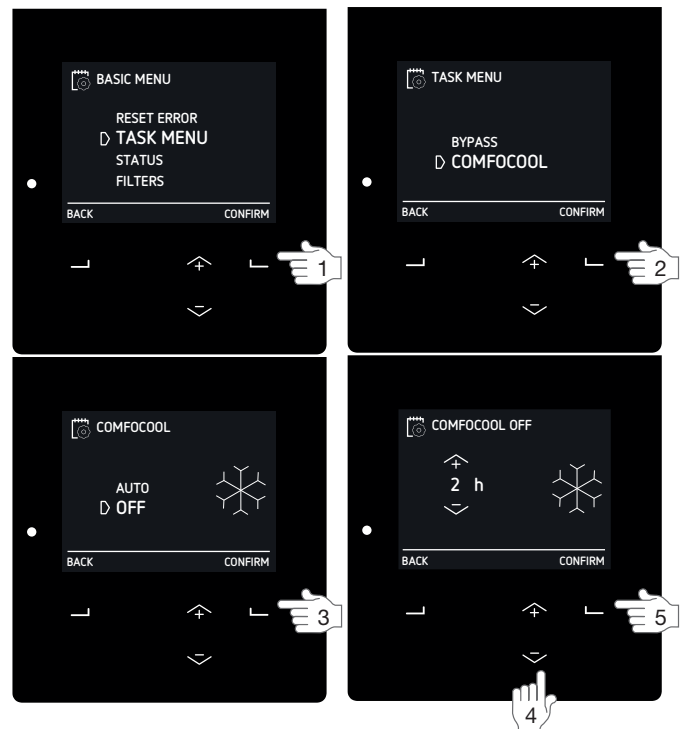

<sup>3</sup> This menu is only visible when the ancillary is connected to the unit.

### 3.6 Checking the status of the unit



The unit is equipped with a lot of automated controls which influence the behaviour of the unit.

Therefore the unit has a STATUS menu where you can see which controls are active. Next to the active controls general status information of the unit is also available in the STATUS menu. See the table below for the information that can be found in the STATUS menu.

Menu item	Function
ERRORS <sup>1</sup>	To view the current error codes.
FLOW RESTRICTIONS <sup>4</sup>	<p>To view the reason why the flow rate is influenced.</p> <ul style="list-style-type: none"> <li>■ + HUMIDITY PROTECTION: The unit is running at a higher airflow rate than normal due to a request from the humidity protection control. See chapter “SENSOR VENTILATION<sup>2</sup>” for more information about the humidity protection control;</li> <li>■ + HUMIDITY COMFORT: The unit is running at a higher airflow rate than normal due to a request from the humidity comfort control. See chapter “SENSOR VENTILATION<sup>2</sup>” for more information about the humidity comfort control;</li> <li>■ + TEMPERATURE PASSIVE: The unit is running at a higher airflow rate than normal due to a request from the temperature passive control. See chapter “SENSOR VENTILATION<sup>2</sup>” for more information about the temperature passive control;</li> <li>■ + RF SENSOR: The unit is running at a higher airflow rate than normal due to a request from an RF sensor. See chapter “RF SETTINGS<sup>2,8</sup>” for more information about the RF sensor control;</li> <li>■ + 0-10V INPUT: The unit is running at a higher airflow rate than normal due to a request from an analog input;</li> <li>■ + 0-10V INPUT (1-4): = The unit is running at a higher airflow rate than normal due to a request from analog input (1-4);</li> <li>■ + COMFOCOOL: The unit is running at a higher airflow rate than normal due to a request from the ComfoCool Q600. Turn off the ComfoCool Q600 if you would like to decrease the airflow;</li> <li>■ + PREHEATER: The unit is running at a higher airflow rate than normal due to a request from the preheater; Turn off the Preheater if you would like to decrease the airflow.</li> </ul> <ul style="list-style-type: none"> <li>■ - RESISTANCE: The unit is running at a lower airflow rate than normal because one or two fans are on the maximum fan duty;</li> <li>■ - RESISTANCE GUARD: The unit is running at a lower airflow rate than normal because the maximum allowed static pressure is reached;</li> <li>■ - NOISE GUARD: The unit is running at a lower airflow rate than normal because the maximum allowed noise level for the preset is reached;</li> <li>■ - FROST PROTECTION: The unit is running at a lower airflow rate than normal because the minimal air temperature is reached;</li> <li>■ - PREHEATER: The unit is running at a lower airflow rate than normal due to a request from the preheater;</li> <li>■ - BYPASS: The unit is running at a lower airflow rate than normal due to a request from the bypass. See chapter “Heat recovery control (bypass) for a specific duration” for more information about the bypass control.</li> </ul>
UNIT	<p>To view the unit information.</p> <ul style="list-style-type: none"> <li>■ HRU TYPE: view the unit type name;</li> <li>■ FIRMWARE VERSION: view the unit firmware version;</li> <li>■ SERIAL NUMBER: view the serial number of the main board in the unit.</li> </ul>
SCHEDULER	<p>To view the scheduler step in which the unit is currently running.</p> <ul style="list-style-type: none"> <li>■ VENTILATION: view which step of the ventilation scheduler is in operation;</li> <li>■ COMFOCOOL<sup>3</sup>: view which step of the ComfoCool Q600 scheduler is in operation;</li> <li>■ POSTHEATER<sup>3</sup>: view which step of the Postheater scheduler is in operation;</li> </ul>
TEMP. AND HUMIDITY	<p>To view the current temperature and humidity of the airflows.</p> <ul style="list-style-type: none"> <li>■ EXTRACT AIR TEMP.: view the current temperature of the extract airflow;</li> <li>■ EXTRACT AIR HUM.: view the current humidity level of the extract airflow;</li> <li>■ EXHAUST AIR TEMP.: view the current temperature of the exhaust airflow;</li> <li>■ EXHAUST AIR HUM.: view the current humidity level of the exhaust airflow;</li> <li>■ OUTDOOR AIR TEMP.: view the current temperature of the outdoor airflow;</li> <li>■ OUTDOOR AIR HUM.: view the current humidity level of the outdoor airflow;</li> <li>■ SUPPLY AIR TEMP.: view the current temperature of the supply airflow;</li> <li>■ SUPPLY AIR HUM.: view the current humidity level of the supply airflow.</li> </ul>
BYPASS STATE	<p>To view the current state of the bypass control.</p> <ul style="list-style-type: none"> <li>■ The percentage of bypassed air is shown.</li> </ul>
FROST PROTECTION	<p>To view the current state of airflow reduction caused by the frost protection function.</p> <ul style="list-style-type: none"> <li>■ The percentage of supply air reduction is shown.</li> </ul> <p>If the installer has indicated there is no fire place present, the airflow of the extract air will not be reduced. The frost protection function will cause an unbalance in the airflow.</p> <p>If the installer has indicated the presence of a fire place, the airflow of the extract air will have the same reduction as the airflow of the supply air. The frost protection function will not cause an unbalance in the airflow.</p>
FROST PREHEATER <sup>3</sup>	<p>To view the current state of the preheater caused by the frost protection function.</p> <ul style="list-style-type: none"> <li>■ The current power consumption of the preheater is shown.</li> </ul>
POSTHEATER <sup>3</sup>	<p>To view the current state of the post-heater.</p> <ul style="list-style-type: none"> <li>■ The percentage and current state of the post-heater control is shown.</li> <li>■ The supply air temperature before the postheater is shown.</li> <li>■ The supply air temperature after the postheater is shown.</li> </ul>

<sup>1</sup> This menu is only visible when errors occur.

<sup>2</sup> This menu is only visible when the advanced mode is active.

<sup>3</sup> This menu is only visible when the ancillary is connected to the unit.

<sup>4</sup> This menu is only visible when an automatic control requires a different airflow setting than requested.

<sup>8</sup> This menu is only visible when the unit has RF functionality.

Menu item	Function
ANALOG INPUT <sup>3</sup>	To view the current state of the analog input(s) ■ 0-10V INPUT 1 <sup>3</sup> : view the voltage level of the first analog input. ■ 0-10V INPUT 2 <sup>3</sup> : view the voltage level of the second analog input. ■ 0-10V INPUT 3 <sup>3</sup> : view the voltage level of the third analog input. ■ 0-10V INPUT 4 <sup>3</sup> : view the voltage level of the fourth analog input.
SUBSOIL HEAT EXCH. <sup>3</sup>	To view the current state of the regulated subsoil heat exchanger (e.g. ComfoFond-L Q). ■ STATE: view the current state of the regulated subsoil heat exchanger pump; ■ OUTDOOR AIR TEMP.: view the current outdoor air temperature; ■ GROUND TEMPERATURE: view the estimated temperature of the regulated subsoil heat exchanger brine liquid.
COMFOCOOL <sup>3</sup>	To view the current state of the ComfoCool Q600. ■ STATE: view the current ComfoCool Q600 mode and the current ComfoCool Q600 supply air temperature; ■ CONDENSER TEMP: view the current condenser temperature. If the condenser temperature is between 52°C and 58°C the unit will increase the airflow. If the condensor temperature exceeds 58°C, the ComfoCool Q600 will go into COMFOCOOL_HEAT ERROR and will be stopped until the error has been reset.
SEASON DETECTION	To view the current season detection state. ■ SEASON: view the current season mode; ■ LIMIT RMOT HEAT: view the set RMOT <sup>5</sup> below which the (central) heating system is normally active; ■ LIMIT RMOT COOL: view the set RMOT <sup>5</sup> above which the (central) cooling system is normally active; ■ CURRENT RMOT: view the current RMOT <sup>5</sup> .
FANS	To view the current state of the fans
SUPPLY FAN	■ FAN SPEED: view the current speed of the fan. ■ FAN DUTY: view the current duty of the fan. ■ FLOW: view the current airflow of the fan.
	■ FAN SPEED: view the current speed of the fan. ■ FAN DUTY: view the current duty of the fan. ■ FLOW: view the current airflow of the fan.
ENERGY	To view the energy consumption and saved energy.
POWER CONSUMPTION	■ VENTILATION: view the current electrical consumption of the fans. ■ PREHEATER: view the current electrical consumption of the preheater. ■ YEAR TO DATE: view the energy consumption of the fans since the beginning of the year. ■ TOTAL: view the total energy consumption of the fans since the unit was commissioned.
AVOIDED HEATING	■ ACTUAL POWER: view the current avoided heating <sup>6</sup> power. ■ YEAR TO DATE: view the avoided heating <sup>6</sup> energy since the beginning of the year. ■ TOTAL: view the avoided heating <sup>6</sup> energy since the unit was commissioned.
AVOIDED COOLING	■ ACTUAL POWER: view the current avoided cooling <sup>7</sup> power. ■ YEAR TO DATE: view the avoided cooling <sup>7</sup> energy since the beginning of the year. ■ TOTAL: view the avoided cooling <sup>7</sup> energy since the unit was commissioned.
TOTAL SAVINGS	■ YEAR TO DATE: view the total energy savings (due to heat recovery) since the beginning of the year. ■ TOTAL: view the total energy savings (due to heat recovery) since the unit was commissioned.

### 3.7 Setting the unit clock

The unit has an internal clock which is used for the scheduler.

1. Navigate to BASIC OPTIONS as instructed in the chapter “How to navigate through the unit menu”.
2. Navigate to CLOCK.
3. Navigate to the current year.
4. Navigate to the current month.
5. Navigate to the current day.
6. Navigate to the current hour.
7. Navigate to the current minute.



<sup>3</sup> This menu is only visible when the ancillary is connected to the unit.

<sup>5</sup> RMOT = running mean outdoor temperature (average temperature over past five days).

<sup>6</sup> The amount of energy which has been saved because an external heating source did not need to be switched on.

<sup>7</sup> The amount of energy which has been saved because an external cooling source did not need to be switched on.

### 3.8 Setting the unit display brightness

1. Navigate to BASIC OPTIONS as instructed in the chapter “How to navigate through the unit menu”.
2. Navigate to BRIGHTNESS.
3. Navigate to the desired brightness.

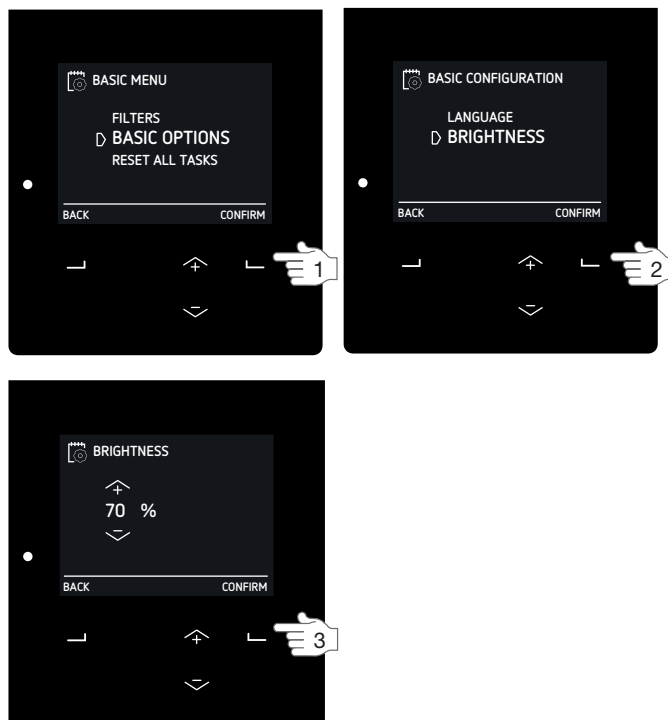

### 3.9 Reset options

When the unit is displaying a malfunction code follow the instructions in the chapter “Malfunctions”. In addition to resetting malfunction codes the unit is also equipped with the following other reset functions:

Menu item	Function
RESET EXCL SCHEDULE (You can find this menu under RESET ALL TASKS)	When this menu is activated all settings in the TASK MENU excluding the set scheduler(s) will be returned to the (default) factory settings.
RESET INCL SCHEDULE (You can find this menu under RESET ALL TASKS)	When this menu is activated all settings in the TASK MENU including the set scheduler(s) will be returned to the (default) factory settings.
INSTALLER DEFAULT <sup>2</sup> (You can find this menu under ADVANCED SETTINGS)	When the option RESET is activated all software values will be returned to the (default) installer settings.

<sup>2</sup> This menu is only visible when the advanced mode is active.

### 3.10 Advanced mode



In the basic mode you have limited control over the units automated control options. In the advanced mode you can set many automated control options to your needs. You can find all these settings in the menu **ADVANCED SETTINGS<sup>2</sup>**. This menu is only accessible when the unit is in advanced mode.

#### 3.10.1 Switch between basic and advanced mode

When in basic mode:

1. Select **SHIFT** in the main screen.
2. Select **ADVANCED**.

When in advanced mode:

1. Select **SHIFT** in the main screen.
2. Select **BASIC**.



#### 3.10.2 SENSOR VENTILATION<sup>2</sup>



In the **SENSOR VENTILATION<sup>2</sup>** menu you can influence the following control functions which automatically increase the airflow setting (demand control) under favourable conditions.

Each control function can be set to:

Menu item	Function
ON	The unit will respond to the control function in AUTO and MANUAL mode.
AUTO ONLY	The unit will only respond to the control function in AUTO mode. When the unit is switched to manual mode the unit will deactivate this control function.
OFF	The unit will deactivate this control function.

#### TEMPERATURE PASSIVE<sup>2</sup>

The **TEMPERATURE PASSIVE<sup>2</sup>** control can be used to temper the indoor temperature by ventilating on airflow PRESET 3. The **TEMPERATURE PASSIVE<sup>2</sup>** control will activate airflow PRESET 3 when the following conditions are met:

- **TEMPERATURE PASSIVE<sup>2</sup>** control is permitted;
- For **MANUAL** mode setting ON;
- For **AUTO** mode setting **AUTO ONLY** or ON.
- It is cooling season;
- The indoor temperature is significantly higher than the temperature outside;
- The bypass control is in **AUTO** mode;
- The ComfoCool is turned off;
- The unit has not been turned off within the last two minutes;
- Both fans are working;
- The extract and supply temperature sensor are working.

This functions is set to OFF by default.

#### HUMIDITY COMFORT<sup>2</sup>

The **HUMIDITY COMFORT<sup>2</sup>** control can be used to keep the indoor air quality at an acceptable level, based on absolute humidity. The **HUMIDITY COMFORT<sup>2</sup>** control will increase the airflow when the following conditions are met:

- **HUMIDITY COMFORT<sup>2</sup>** control is permitted;
- For **MANUAL** mode setting ON;
- For **AUTO** mode setting **AUTO ONLY** or ON.
- The indoor humidity is higher than the reference humidity;
- The unit has not been turned off within the last two minutes.

This functions is set to **AUTO ONLY** by default.

#### HUMIDITY PROTECTION<sup>2</sup>

The **HUMIDITY PROTECTION<sup>2</sup>** control can be used to protect the house against high humidity by ventilating on airflow PRESET 3. The **HUMIDITY PROTECTION<sup>2</sup>** control will activate airflow PRESET 3 when the following conditions are met:

- **HUMIDITY PROTECTION<sup>2</sup>** control is permitted;
- For **MANUAL** mode setting ON;
- For **AUTO** mode setting **AUTO ONLY** or ON.
- The relative humidity of the extract air exceeds 75%;
- The unit has not been turned off within the last two minutes.

This functions is set to ON by default.

The **HUMIDITY PROTECTION<sup>2</sup>** is based on a central sensor. Using a local humidity sensor for the wet rooms where the humidity is produced, is always faster and more reliable.

Humidity protection works for high humidity only. It doesn't protect the building from low humidity.

<sup>2</sup> This menu is only visible when the advanced mode is active.

### 3.10.3 TEMPERATURE PROFILE<sup>2</sup>

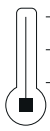

In the advanced TEMPERATURE PROFILE<sup>2</sup> menu you can influence the temperature of the different temperature profiles (WARM, NORMAL and COOL) which you can set in the TASK MENU.

First choose which temperature profile mode you would like to use in the menu SET MODE<sup>2</sup>:

- ADAPTIVE = The desired indoor temperature varies with the outdoor climate (adaptive comfort technology);

- FIXED = The desired indoor temperature is fixed and does not depend on the outdoor climate.

In the ADAPTIVE mode the unit uses the RMOT<sup>5</sup> for determining the desired indoor temperature. You can only influence this desired indoor temperature by 1.5°C from the NORMAL setting by activating the temperature profile COOL or WARM. The NORMAL setting is 21.5°C @ 0°C RMOT<sup>5</sup>. For every °C increase in RMOT<sup>5</sup> the temperature is adjusted by +0.11°C.

If you choose the FIXED mode you can set the temperature for each temperature profile in the FIXED PRESETS<sup>2</sup> menu.

Temperature profiles	Default value FIXED	Value ADAPTIVE
WARM	24°C / 76°F	NORMAL +1.5°C
NORMAL	20°C / 68°F	-
COOL	18°C / 64°F	NORMAL -1.5°C

### 3.10.4 UNITS<sup>2</sup>

In the menu UNITS<sup>2</sup> you can change the displayed units of the temperature and airflow rate.

Menu item	Default value
TEMPERATURE <sup>2</sup>	CELSIUS
FLOW <sup>2</sup>	l/s

### 3.10.5 SEASON DETECTION<sup>2</sup>



To prevent the unit from counteracting with external heating (e.g. central heating) and cooling (e.g. air conditioner) units in the dwelling, the unit is equipped with a function to detect the current season. The detection is based on the RMOT<sup>5</sup>. In the menu SEASON DETECTION<sup>2</sup> you can set the RMOT<sup>5</sup> temperature on which the HEATING SEASON<sup>2</sup> and COOLING SEASON<sup>2</sup> will start.

By selecting the option STARTS NOW you can start the season mode instantly which will save the current RMOT<sup>5</sup> as the desired new season limit.

Menu item	Default value
HEATING LIMIT RMOT <sup>5</sup>	11°C / 51°F
COOLING LIMIT RMOT <sup>5</sup>	20°C / 68°F

### 3.10.6 RF SETTINGS<sup>2,8</sup>



In the RF SETTINGS<sup>2,8</sup> menu you can set the control options of the RF-signals. The set control option is the same for all connected RF ancillaries.

In the menu RF SENSOR PRIORITY<sup>2,8</sup> you can set when the unit will respond to a RF-signal:

Menu item	Function
ON	The unit will respond to the RF-signal in AUTO and MANUAL mode.
AUTO ONLY	The unit will only respond to the RF-signal in AUTO mode. When the unit is switched to manual mode the unit will ignore the RF-signal.
OFF	The unit will ignore the RF-signal.

In the menu RF SENSOR FUNCTION<sup>2,8</sup> you can set how the unit will respond to a RF-signal:

Menu item	Function
FLOW PROPORTIONAL	The unit will translate the signal from a RF sensor to a corresponding airflow between the starting and maximal set airflow.
FLOW PRESET	The unit will translate the signal from a RF sensor to one of the preset airflows <sup>8</sup> .

When the unit is equipped with a RF-PCB you can set the unit pairing mode with the menu START RF PAIRING<sup>2,3</sup>. When the unit is in pairing mode you can commission one RF ancillary as described in its own manual.



**The commission procedure for the RF ancillaries is different from the older Zehnder units. Do not disconnect the power to the unit, instead access the menu START RF PAIRING<sup>2,3</sup>.**

### 3.10.7 POSTHEATER<sup>2,3</sup>

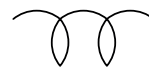

In the POSTHEATER<sup>2,3</sup> menu you can set the desired comfort temperature for the supply air. When the Postheater is set to COMF. SUPPLY the Postheater will turn on during the heating and shoulder season when the supply air temperature is below the set value.

<sup>2</sup> This menu is only visible when the advanced mode is active.

<sup>3</sup> This menu is only visible when the ancillary is connected to the unit.

<sup>5</sup> RMOT = running mean outdoor temperature (average temperature over past five days).

<sup>8</sup> This menu is only visible when the unit has RF functionality.



## 4 Certification and warranty

### Warranty conditions

The unit is covered by a manufacturer's warranty for a period of 24 months after fitting up to a maximum of 30 months after the date of manufacture. Warranty claims may only be submitted for material faults and/ or construction faults arising during the warranty period. In the case of a warranty claim, the unit must not be dismantled without written permission from the manufacturer. Spare parts are only covered by the warranty if they were supplied by the manufacturer and have been installed by an approved installer.

The warranty becomes invalid if:

- The guarantee period has elapsed;
- The unit is used without filters;
- Parts are used that have not been supplied by the manufacturer;
- Non-authorized changes or modifications have been made to the unit;
- Installation has not been carried out according to the applicable regulations;
- The defects are due to incorrect connection, inexpert use, or contamination of the system.

On-site (dis)assembly costs are not covered by the terms of the warranty. This also applies to normal wear and tear. Zehnder retains the right to change the construction and/or configuration of its products at any time without being obliged to alter previously delivered products.

### CE certification

Zehnder Group Nederland B.V.  
Lingenstraat 2 • 8 028 PM Zwolle-NL  
T +31 (0)38 4296911 • F + 31 (0)38 4225694  
Company register Zwolle 05022293

### Machine description

### Complies with the following directives

Zwolle, 04-04-2016  
Zehnder Group Nederland B.V.



A.C. Veldhuijzen,  
Head of R&D  
Competence Center ComfoSystems

### Liability

The unit has been designed and manufactured for use in balanced ventilation systems incorporating Zehnder heat recovery systems. Any other application is seen as inappropriate use and can result in damage to the unit or personal injury, for which the manufacturer cannot be held liable. The manufacturer is not liable for any damage originating from:

- Non-compliance with the safety, operating and maintenance instructions in this document;
- The use of components not supplied or recommended by the manufacturer.  
Responsibility for the use of such components lies entirely with the installer;
- Normal wear and tear.

### Disposal

 **Dispose of the unit in an environmentally friendly manner. Do not dispose of the unit with your domestic waste.**

1. Contact the supplier about the possibilities to return the unit.
2. If the unit cannot be returned, check the local regulations for the options on recycling the components.
3. Do not dispose of the batteries from the wireless (RF) operating devices as normal waste. They must be discarded at designated disposal locations.

### EEC declaration of conformity

Heat recovery units:	ComfoAir Q series
Machinery Directive	(2006/42/EEC)
Low Voltage Directive	(2006/95/EEC)
EMC Directive	(2004/108/EEC)



## 5 Maintenance

Part of system	Limit	Responsible	Procedure
Filters	6 months	User	Replace the filters
Valves	6 months	User	Clean the valves
Grilles	6 months	User	Clean the grilles
Operating device	6 months	User	Clean the operating device
Condensation drain	6 months	User	Fill the condensation drain
System inspection and cleaning	4 years	Installer or service engineer	-

Zehnder recommends a maintenance contract with a specialist ventilation maintenance company. Some installers provide a maintenance contract in which the user maintenance can be integrated. Contact the supplier of the unit for a list of registered installers nearby.

The warranty becomes invalid if:

- Parts are used that have not been supplied by the manufacturer;
- The unit is used without filters.

**⚠ Do not disconnect the power to the unit, unless instructed otherwise in the manual. This can lead to a build-up of moisture and result in problems with mould.**

**⚙ Perform the maintenance tasks within the suggested time periods. Failure to do this can result in the ventilation systems performance to be compromised.**

**👉 Keep a clearance in front of the unit of at least 1m. This room is needed to carry out the maintenance activities.**

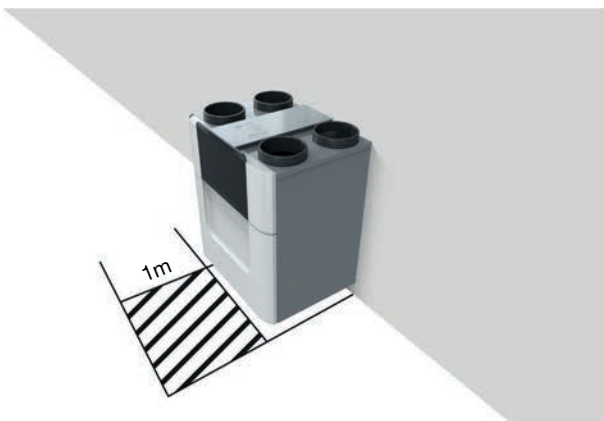

### 5.1 Fill the condensation drain

The condensation drain is connected to the domestic waste-water system. To prevent sewer smells from entering your home, the water seal of the domestic waste-water system must always contain water. You can achieve this by pouring a cup of water into the water seal.

### 5.2 Clean the operating device

Activate the child lock on the display, to prevent any changes to the settings caused by accidentally pressing the buttons. Clean any operating device present in your home at least every six months. Use a dry duster or vacuum cleaner to remove the dust. Do not use water or any other liquid.

### 5.3 Clean the grilles

**⚠ Clean any grille present in and outside your home at least every six months.**

1. Keep hold of the grille on its outer edge and pull it completely out of the wall or ceiling (if not screwed down).
2. Clean the grille with a soft brush or vacuum cleaner.

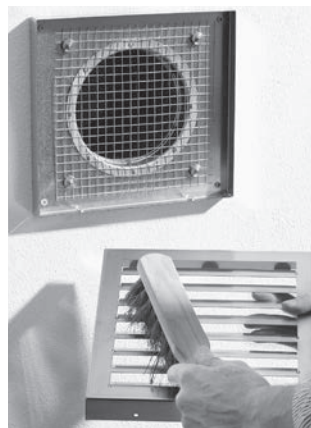

3. Clean the filter behind the grille (if present) with a soft brush or vacuum cleaner.
  - Do not remove the foam behind the grille (if present) as it would negatively influence the system performance.
4. Place the grille back in the wall or ceiling.

## 5.4 Clean the valves

### **Clean any valve present in your home at least every six months.**

1. Keep hold of the valve on its outer edge and pull it completely out of the wall or ceiling with a rotating movement.  
If a rubber ring is fitted: Take care when removing the valve to leave the rubber ring in place.



2. Mark the location and setting of the valve.
  - Do not change the settings of the valve as it would negatively influence the system performance;
  - Do not swap the valves with one another as it will negatively influence the system performance;
3. Remove the filter behind the valve (if present).



4. Clean the valve with a soft brush, vacuum cleaner or soapy water.



5. Rinse the valve and then dry.
6. Replace the filter behind the valve (if present).
7. Place the valve back in the wall or ceiling.

### **Supply valve ComfoValve Luna S125**



The ComfoValve Luna S125 supply valve is equipped with a detachable design cover. Therefore this valve can stay in the wall or ceiling during cleaning.

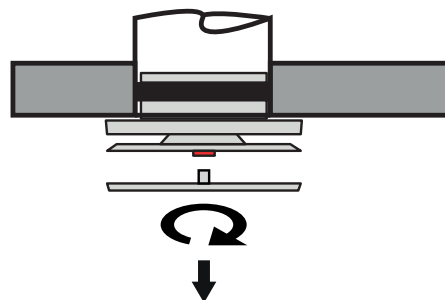

Turn the design cover a quarter counterclockwise and then remove it from the valve.

## 5.5 Replacing the internal filters

**⚠️ Replace the filters at least every six months. This will insure a comfortable and healthy air quality and will protect the unit from pollution.**

### 5.5.1 View filter status

When the filters need replacing the unit will automatically give a filter warning. The filter warning is indicated as follows:

- The LED light on the unit flashes;
- The display on the unit shows the warning message: EXPECT FILTER CHANGE SOON;
- The display on the unit shows the error message: CHANGE FILTERS NOW;
- The operating device(s) can show a message. Refer to the manual of the operating device for more information about the indication for filter replacement.

In the FILTER STATUS menu you can view how many days are left until the filter warning will appear on the display:

1. Navigate to FILTERS as instructed in the chapter “How to navigate through the unit menu”.
2. Navigate to FILTER STATUS.

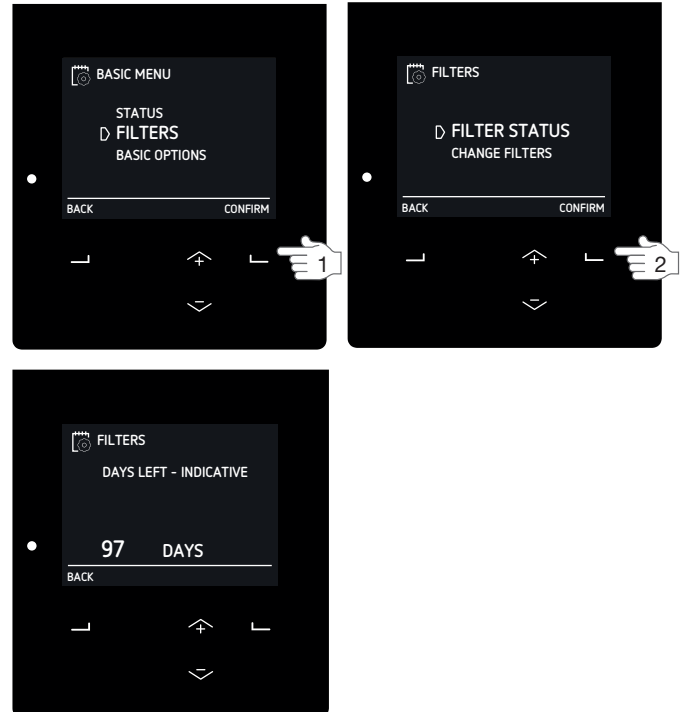

### 5.5.2 Postponing filter warning

When the unit is displaying the message EXPECT FILTER CHANGE SOON you can choose to postpone the message for one day. This way you have time to get new filters without the filter LED blinking all the time.

#### Postponing

Select SUPPRESS.

The filter message will automatically return after one day.

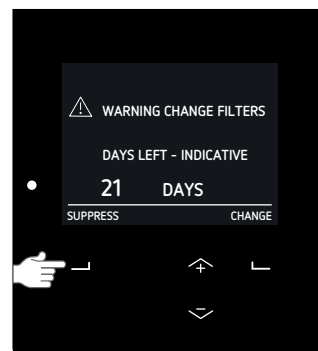

#### Start filter replacement without filter warning

1. Navigate to FILTERS as instructed in the chapter “How to navigate through the unit menu”.
2. Navigate to CHANGE FILTERS.
3. Go to step 4 in chapter “Replacement instruction”.

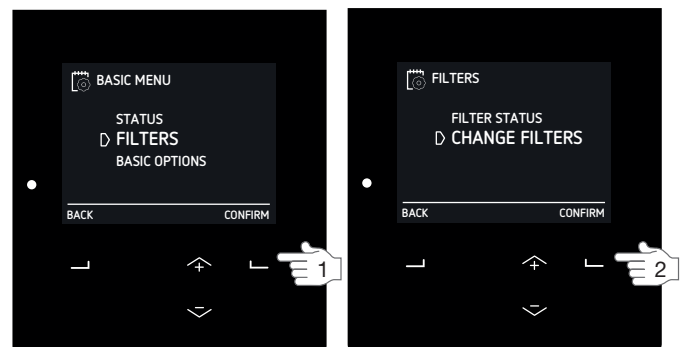

### 5.5.3 Replacement instruction

#### 1. Order new filters

Contact the installer of the unit for providing the correct filters or order online at [www.zehnder.com/buy-filter](http://www.zehnder.com/buy-filter).



Filter set	Order number
G4/G4 (1x/1x)	400502012
F7 <sup>10</sup> /G4 (1x/1x)	400502013

- When the new filters have arrived open the semi-transparent visor.
- Select CHANGE or NOW on the warning message. For safety reasons the unit will stop the ventilation during the filter replacement instructions.
- Follow all the instructions on the display.

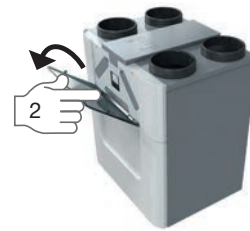

Item	Description
	Remove filter caps.
	Remove old filters.
	Insert new supply filter, with the arrow pointing up, into the unit.
	Insert new extract filter, with the arrow pointing up, into the unit.
	Insert filter caps
	<b>Place the click connection of the filter caps on top of the unit to guarantee an airtight lock.</b>

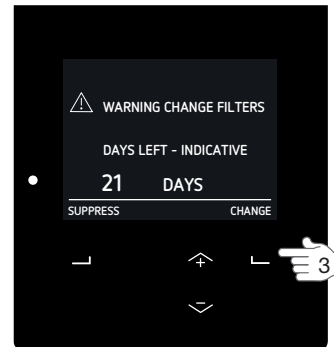

- Select NEXT to go forward after every completed instruction.
- Select BACK to go back to the previous instruction.

- Select CONFIRM to close the filter replacement instructions and start up the ventilation again.
- Close the semi-transparent visor.
- Fill in the maintenance log (if present).

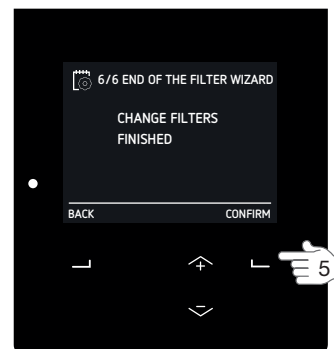

### 5.6 Replace or clean the external filter

The ventilation system can be equipped with an external filter by the installer. When the external filter is equipped with a sensor the display on the unit will show the message EXTERNAL FILTER ALARM when the external filter needs to be replaced or cleaned. In the external filter manual you can find if the equipped external filter has a sensor and how to replace or clean the external filter.

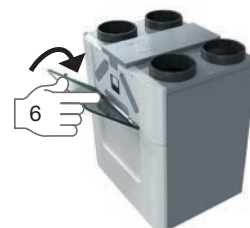

<sup>10</sup> Standard available on the unit with pre-heater.

## 6 Malfunctions

The power to the unit should not be disconnected unless the unit is to be taken out of service due to a serious malfunction or any other compelling reasons.

**⚠ Do not disconnect the power to the unit, unless instructed otherwise in the manual. This can lead to a build-up of moisture and results in problems with mould.**

In the event of a malfunction:

- the LED light on the unit flashes;
- the display on the unit shows the corresponding malfunction code(s);
- the operating device can show a message. The manual of the operating device contains more information about the indication method.

In the event of a filter malfunction, replace the filter as described in the “Maintenance” chapter. In the event of all other malfunctions follow these steps:

1. Navigate to RESET ERROR as instructed in the chapter “How to navigate through the unit menu”.
2. Wait for 2 minutes.

If the error reoccurs:

3. Navigate to STATUS.
4. Navigate to ERRORS.
5. Write down all the malfunction code(s)
  - Select NEXT to view more errors.
6. Select BACK.
7. Navigate to UNIT.
8. Navigate to HRU TYPE.
9. Write down the unit type.
10. Select NEXT
11. Write down the software version
12. Close the semi-transparent visor.
13. Contact the installer or service engineer and provide them with the noted information.

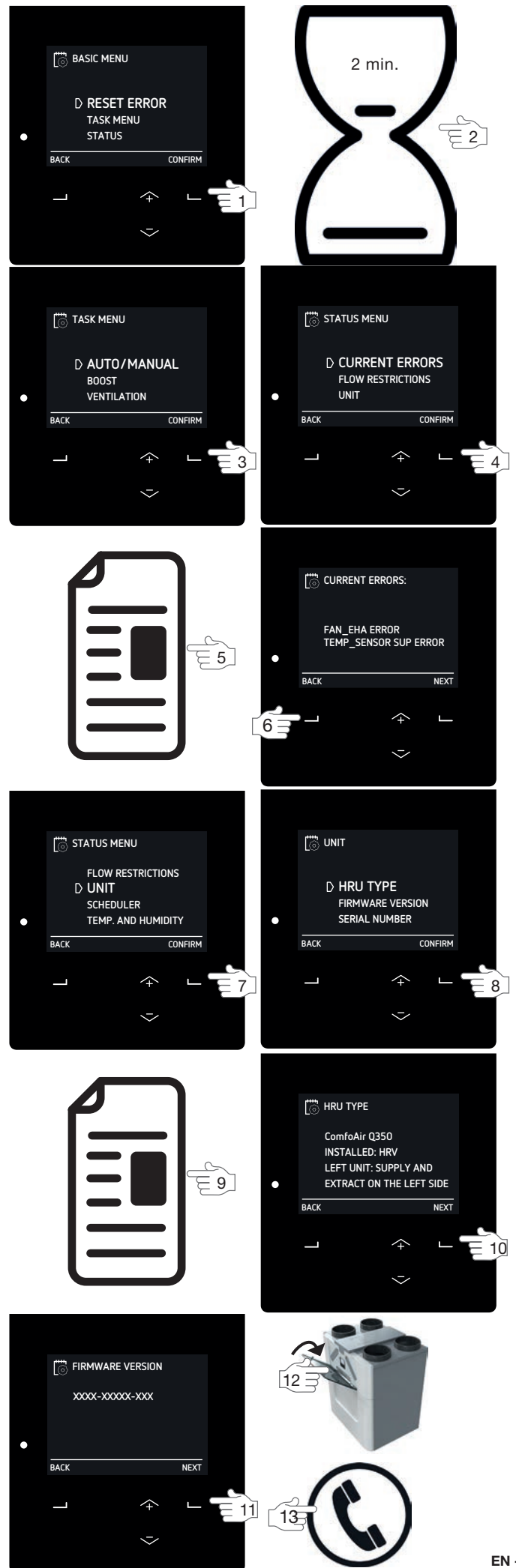

### 6.1 Airflow is not as expected.

Multiple devices and automatic controls can ask for a change in airflow. A request from an automatic safety control will always take precedent over other devices and automatic controls. Therefore it may seem the unit is malfunctioning when you try to change the airflow. In the STATUS menu FLOW RESTRICTIONS you can see which automatic control is changing the airflow. As soon as the automatic control finishes, the unit will respond as expected. In winter conditions with temperatures below 0°C: check your outside grilles for any obstructions due to ice forming.

#### **RF device is not responding anymore**

If the RF SENSOR PRIORITY is set to AUTO ONLY the unit will only respond to the RF-signal in AUTO mode. So when you switch to MANUAL mode the RF device will not change the airflow of the unit.

#### **Wired device is not responding anymore**

If the installer has set the PRIORITY to AUTO ONLY the unit will only respond to the 0-10V signal in AUTO mode. So when you switch to the MANUAL mode the 0-10V device will not change the airflow of the unit.

### 6.2 Condensation on the outside of the unit and/or air ducts

When the unit is installed in an area with a higher average humidity (such as bathroom or wc) the probability of condensation on the outside of the unit is high. This is similar to condensation on a window, no action is needed.

### 6.3 Software update

A registered installer can update the unit firmware to the latest function. When your unit is equipped with a ComfoConnect LAN C you can even authorise the installer to perform the update via Remote Support. If your unit is not equipped with a ComfoConnect LAN C or you do not wish to authorise remote access to your installer, the installer will have to perform the software update in person.

### 6.4 ComfoCool Q600 is not turning on

For safety reasons the unit does not allow the ComfoCool Q600 to turn on in all hot situations. In the following situations the unit will not allow the ComfoCool Q600 to switch on:

- It is forced off by the ComfoCool Q600 timer;
- It is forced off by the ComfoCool Q600 scheduler;
- The unit is in airflow PRESET A;
- It is heating season;
- A unit fan is turned off;
- The bypass is not in AUTO mode;
- The delivered supply air from the unit is less than 3°C hotter than the requested supply air.
- The unit has a ComfoCool Q600 error.

### 6.5 Postheater is not turning on

For safety reasons the unit does not allow the postheater to turn on in all cool situations. In the following situations the unit will not allow the postheater to switch on:

- It is forced off by the postheater timer;
- It is forced off by the postheater scheduler;
- The unit is in airflow PRESET A;
- It is cooling season;
- The supply fan is turned off;
- The heat recovery control (bypass) is not in AUTO mode;
- The unit has been powered up within the last two minutes.

To prevent unnecessary switching (on and off) of the postheater the unit will always wait one minute before turning the postheater on. When the conditions change between off and on within this minute, the unit will start the one minute counter again.

### 6.6 Supply air is too cold

When the outside air temperature is very cold the postheater may not have enough power to heat the supply air to the desired temperature.

# I Commissioning & Inspection Record

## Part 2a - Installation details

2.1 Installation Checklist - General (all systems)		Tick as appropriate	
Has the system been installed in accordance with manufacturer's requirement		Yes	No
Have relevant systems installation clauses been followed as details in tables 1, 3, 5 and 7 applicable		Yes	No
Type of ductwork installed (e.g. rigid, semi-rigid)			
If any deviation from tables 1, 3, 5 and 7, these should be detailed here			
Description of installed controls (e.g. timer, central control humidistat, PIR, etc.)			
Location of document/override controls			
Signature			
Number (if applicable)			
Date of Installation (completion)			

2.2 Installation Engineer's Details	
Engineer's Name	
Company	
Address Line 1	
Address Line 2	
Telephone Number	
Post Code	
Signature	
Competent Person Scheme/ Registration number (if applicable)	
Date of installation (completion)	

2.3d Inspector's Details	
Name	
Company	
Address Line 1	
Address Line 2	
Telephone Number	
Post Code	
Signature	
Competent Person Scheme/ Registration number (if applicable)	
Date of installation (completion)	

## Part 2b - Inspection of installation

This section should be completed by the commissioning engineer prior to completing Part 3.

2.3a Visual inspections - General (all systems)		
Total installed equivalent area of background ventilators in dwelling		mm
Total floor area of dwelling		m <sup>2</sup>
Does the total installed equivalent ventilator area meet the requirements given in tables 5.2a, 5.2b, or 5.2c in ADF?	Yes	No
Have all background ventilators been left in the open position?	Yes	No
Have the correct number and location of extract fans/terminals been installed that satisfies table 5.2a in ADF?	Yes	No
Is the installation complete with no obvious defects present?	Yes	No
Do all internal doors have sufficient undercut to allow air transfer between rooms (i.e. 10 mm over and above final floor finish)	Yes	No
Has all protection/packaging been removed (including background ventilators) such that system is fully functional?	Yes	No
For ducted systems, has the ductwork installation been installed in such manner that air resistance and leakage is kept to a minimum?	Yes	No
Are the correct number and size of background ventilators provided that satisfy ADF?	Yes	No
Has the entire system been installed such that there is sufficient access for routine maintenance and repair/replacement of components?	Yes	No
2.3a Visual inspections - General (systems 3 and 4 only)		
Have appropriate air terminal devices been installed to allow system balance?	Yes	No
Has the heat recovery unit (System 4 only) and all ductwork been effectively insulated where installed in unheated spaces?	Yes	No
Condensation connection is complete and drains to an appropriate location (System 4 only)?	Yes	No
2.3c Other inspections - General (systems 1, 3 and 4 only)		
Upon initial start up, was any abnormal sound or vibration experienced, or unusual smells detected?	Yes	No



### Part 3 - Airflow measurement test and commissioning details

#### 3.1 Test Equipment

Schedule of air flow measurement equipment used (model and serial)	Date of last UKAS calibration
1.	
2.	
3.	

#### 3.3 Air Flow Measurements (extract) - system 3 and 4 only

Room reference (location of terminals)	Measured Air Flow High Rate (l/s)	Design Air Flow High Rate (l/s) Refer to Table 5.1b ADF	Measured Air Flow Low Rate (l/s)	Design Air Flow Low Rate (l/s) Refer to Table 5.1b in ADF
Kitchen				
Bathroom				
En Suite				
Utility				
Other...				
Other...				
Other...				

#### 3.4 Air Flow Measurements (supply) - system 4 only

Room reference (location of terminals)	Measured Air Flow High Rate (l/s)	Design Air Flow High Rate (l/s) Refer to Table 5.1b ADF	Measured Air Flow Low Rate (l/s)	Design Air Flow Low Rate (l/s) Refer to Table 5.1b in ADF
Living Room 1				
Living Room 2				
Dining Room				
Bedroom 1				
Bedroom 2				
Bedroom 3				
Bedroom 4				
Bedroom 5				
Study				
Other...				

#### 3.5 Commissioning - systems 3 and 4 only

Have controls been set-up in accordance with the manufacturer's recommendations?	Yes	No
Have all distribution grilles been locked to prevent un authorised adjustment?	Yes	No





